

F-803 Add Air (Auxiliary Air) Walk-In Hood

The **ISOLATOR** Add Air Walk-In Hood shares all the capabilities of our standard walk-in hood. This fume hood supplies up to 70% of its own exhaust air from the frontmost supply air plenum. It is ideal for situations where the air flow environment is limited. The **ISOLATOR**'s design and construction enhances its value by providing:

- Unparalleled user safety
- Full hood access for easy set ups
- Years of maintenance free service
- Unmatched ease of use
- Unique design qualities for unlimited customization possibilities
- Field conversion between Constant Air Volume (CAV) and Variable Air Volume (VAV)
- Hoods available in “Knock Down” (KD) mode for transport and assembly in restricted areas

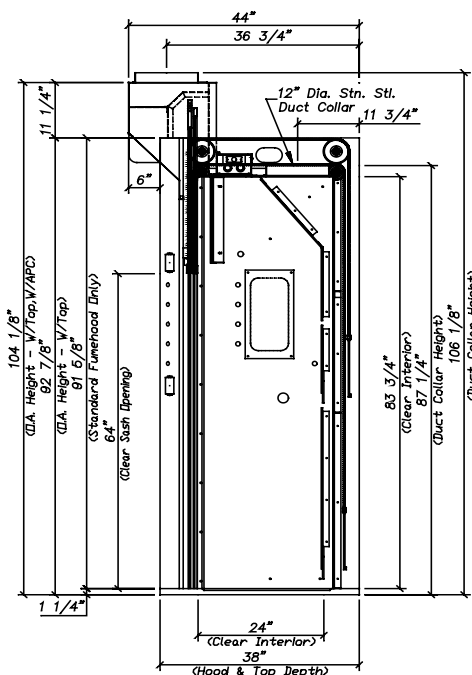

F-803 Add Air Walk-In Hood Features

- Unsurpassed containment (designed and tested to exceed ASHRAE 110-1995)
- Unique chain driven sash mechanism that comes with a lifetime warranty
- Galvanized steel pan superstructure
- Transparent viewpass bypass system
- Stainless steel air foil
- Vertical sashes provide the greatest hood interior access
- Full view stainless steel framed sash with 64" opening
- Quality engineering ensures years of reliable service

F-800 Series – Auxiliary Air Walk-In Hoods – Ordering Information**F-803 Add Air Walk-In Hood Air Flow Data**

Catalog Number	Duct Diameter	Exhaust Open 28" @ 100 FPM	Supply Open 28" @ 100 FPM
F-803-48	1 : 10"	851 CFM @ .43" SP	501 CFM @ .15" SP
F-803-60	1 : 12"	1120 CFM @ .36" SP	659 CFM @ .12" SP
F-803-72	1 : 12"	1389 CFM @ .50" SP	818 CFM @ .19" SP
F-803-96	2 : 10"	1927 CFM @ .50" SP	1134 CFM @ .19" SP

F-803 Add Air Walk-In Hood Product Numbers

F-803-48	Add Air Walk-In 48"	Louvered	Framed
F-803-60	Add Air Walk-In 60"	Louvered	Framed
F-803-72	Add Air Walk-In 72"	Louvered	Framed
F-803-96	Add Air Walk-In 96"	Louvered	Framed

F-803 Add Air Walk-In Hood Liner Options

White Polyglass is standard. Please see the **Hood Liners** section for available options.

F-803 Add Air Walk-In Hood Electrical Options

Fascia is pre-punched with two electrical cutouts (four cutouts total). Please see the **Electrical Fixtures** section for available options.

F-803 Add Air Walk-In Hood Plumbing Fixtures

Fascia is pre-punched with five 3/4" dia. holes to accept rod driven remote fixtures (ten holes total). Please see the **Plumbing Fixtures** section for available options.

F-803 Add Air Walk-In Hood Fume Hood Accessories

Please see the **Fume Hood Accessories** section for available options.

F-800 Series – Auxiliary Air Walk-In Hoods – Product Dimensions

F-800 Series – Auxiliary Air Walk-In Hoods – Product Dimensions

F-803-48 – 48" Add Air Walk-In Hood

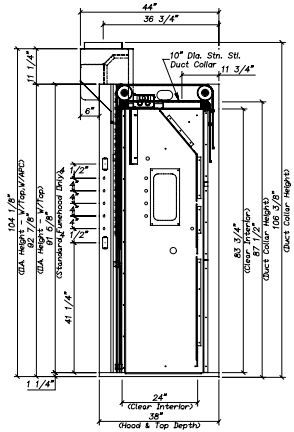
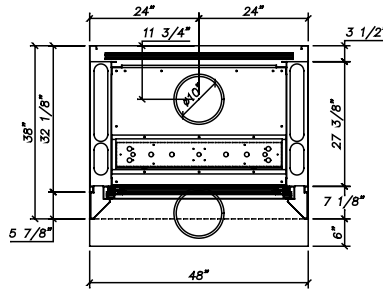
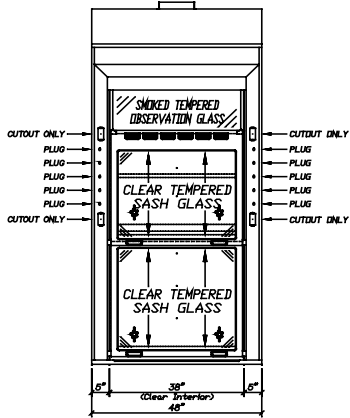

F-803-60 – 60" Add Air Walk-In Hood

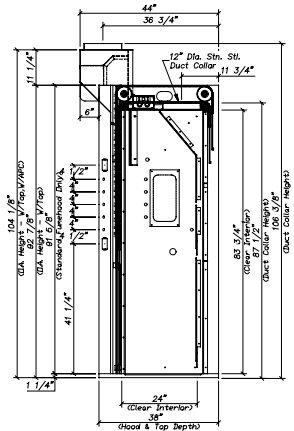
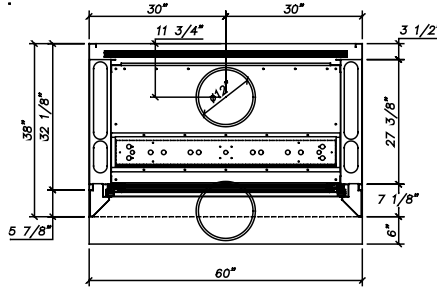
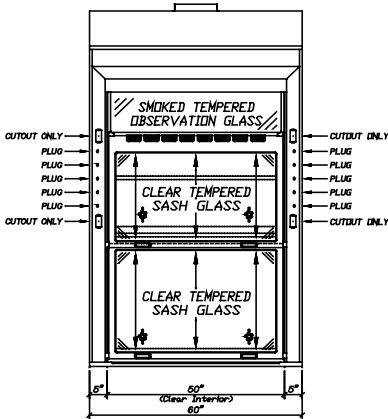

F-803-72 – 72" Add Air Walk-In Hood

